

PRODUCT No. 23903

PENTAX **MUE** **super**

SERVICE MANUAL
ENGLISH



Disassembling and assembling procedures are almost the same as 23900 and/or 23901. Therefore, the details of disassembling and assembling procedures are abbreviated.

Here is explained about special items for 23903.

Disassembly

1. Bottom cover assy. (A400)
 - CSS 1.7 x 3 x 2
 - CSS 1.7 x 2
 - Connector seat (A23)
2. Winding lever assy. (0-C69)
 - Cover screw (C139-01) left handed 23600K-C135-A
 - Winding lever nut (C8) left handed 23600K-C134-A-2
 - Winding lever assy, (0-C69)
 - Winding lever friction spring (C7-01)
3. Rewinding knob assy. (0-D6), ASA ring assy. (D-D11-01)
 - Rewinding knob assy. (0-D6)
 - Nut (D15)
 - *Washer (D21)
 - ASA ring assy. (0-D11-01)
 - *Washer (D21)
 - To adjust the torque of click of ASA ring.
4. Top cover assy. (A300)
 - Top cover retainer screw A (A333) x 2
 - B (A334)
 - C (A342) x 2
 - D (A345)
 - *Top cover assy. (A300)
 - *Top cover assy. (A300)
 - Material of Top cover assy. (A300) is a plastic. But the surface is made conductive by surface treatment. So that the electrical conductive does not apply on the back of Top cover assy. (A300).
5. Unsoldering
 - 1) P.C. board pattern (T100)

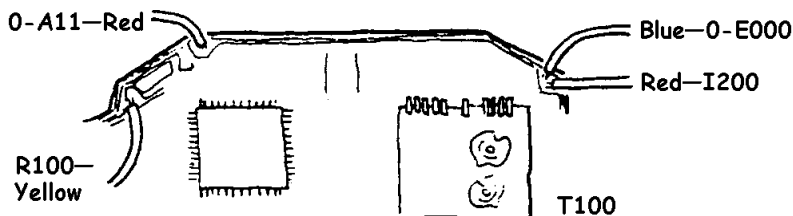

- 2) Relay P.C. board assy. (0-A129)
 - Before unsoldering, take out Insulation seal (A152) to prevent melting by soldering iron.

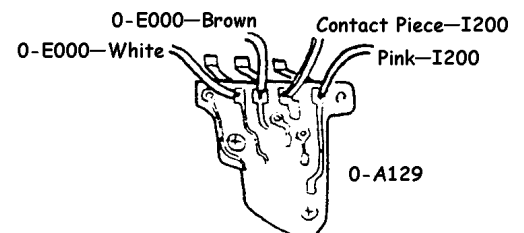

3) f-volume (K101)

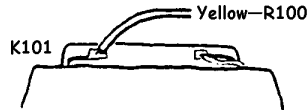

4) Hot shoe contact A (N4), Hot shoe contact C (N9)

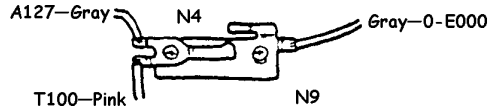

5) EF switch contact piece (A44)

Before unsoldering, take out ASA volume (R100)

ASA volume retainer screw (A16-01)

CNL-D 1.7 x 2.5

ASA volume (R100)

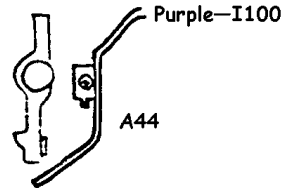

6) Connector base plate assy. (0-A21)

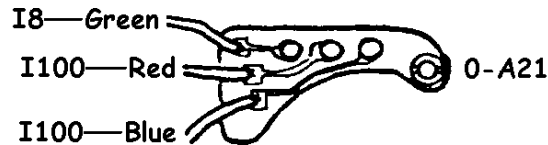

6. Self-timer charge lever assy. (0-A118)

Self-timer screw (A122)

231K-H50

Self-timer charge lever assy. (0-A118)

Self-timer collar (A123)

W30

7. Body covering

Body covering, right (A19)

Body covering, left (A20)

After peel off, re-install Self-timer charge lever assy. (0-A118)

8. Front board and Mirror housing complete assy.

At the charged condition.

CNL-D 1.7 x 3 x 2

P.C. board pattern retainer (I1)

W14

Front board retainer screw (A132-01) x 4

9. P.C. board pattern (T100)

T-CNL-E 1.7 x 4

Hot shoe contact piece A (N4)

Insulation collar (N8)

Insulation plate (N13)

T-CNL-E 1.7 x 3

Hot shoe contact piece C (N9)

CNL-D 1.4 x 3

LED retainer collar (T212)

*PC board pattern (T100)

LED part in P. C. board pattern (T100) should be taken out straight and carefully to prevent making scratches on Shutter speed scale indication plate (M10).

*P.C. board pattern (T100)

It is recommended that P.C. board pattern (T100) is taken out from Mirror housing under the condition separated from Body proper (A1). due to difficulty of LED part taken out and/or installed.

Assembly and Adjustment

1. Cocked indicator assy. (0-C23) Check the spring tension.

At the released condition, the spring should have no tension.

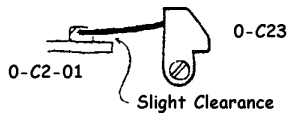

If the spring tension is stronger at the charged condition, 2nd curtain speed will be affected. Accordingly, 1/2000sec will be changed by its spring tension. (1/2000sec should be not changed by its spring tension.)

2. Adjustment of Main SW

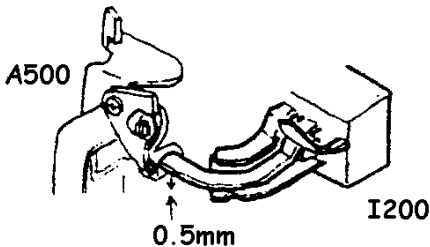

At the condition of release plate assy. (A500) goes up completely, adjust 0.5mm clearance between the contact pieces by turning eccentric screw.

Adjust the clearance by eccentric screw in the range shown below to prevent the side of screw touching the body when the shutter rod pushed down or up.

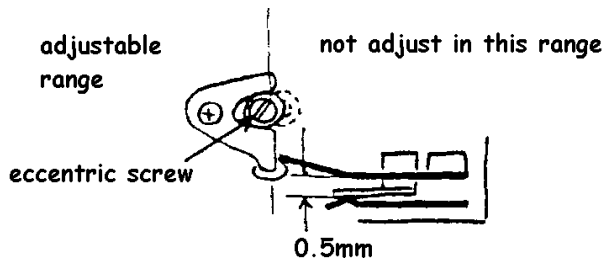

If the clearance is wider than 0.5mm, the shutter will be stayed open at the 1st exposure when released by Self-timer or Winder.

3. EF- switch contact piece (A44)

The clearance of **A** should be within 0.3mm. Adjust the clearance by bending the part of **B**.

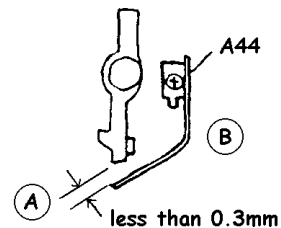

4. Bulb off adjustment

Install *the temporary top cover and set the shutter dial Bulb.

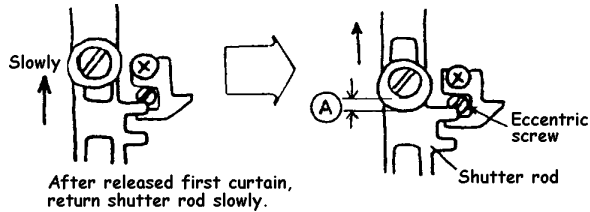

Within the range **A**, 2nd curtain should be released. Adjust by eccentric screw.

After released first curtain, return shutter rod slowly.

Confirmation

- 1) Change the shutter dial 125X. And release the shutter. The shutter speed should be 1/125 sec, not 1/500 or 1/1000sec.
- 2) At the charged condition, release only the shutter block, not push the shutter button. The shutter speed should be 1/125 sec, not 1/500 or 1/1000sec.

*The temporary top cover

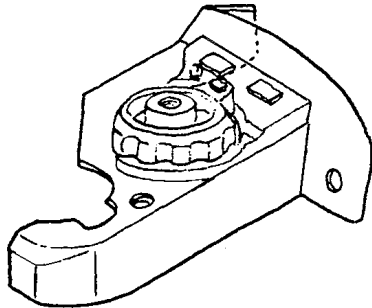

5. Dumper lever plate assy. (0-B90)

Adjust the actuating torque by turning Nut (B96).

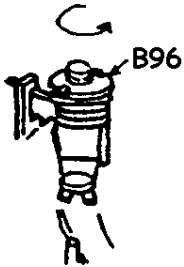

About 1.5 teeth out from the surface of nut (B96).
The level of actuating torque is depends on the greatness of mirror bounce.

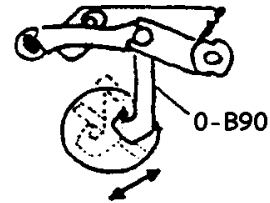

Confirmation

- 1) When drop the mirror seat from up-position, an afterimage of dumper lever plate down and up can be seen after the mirror seat hitted with the dumper lever plate.
- 2) When pushed down the dumper lever plate, and returned slowly, the dumper lever plate should be returned to the original position completely by its own tention. If not, check *Friction washer (B94).

*Friction washer (B94)

Material: Calfskin

- a. It is prohibited to apply any grease in order to the material of friction washer (B94) is calfskin.
- b. When install, fluffy surface should be faced up.

5. Check of Shutter block (0-E000) by using T-adjuster

It is prohibited to adjust the curtain speed and the shutter speed in 0-E000. If the curtain speed and the shutter speed was out of tolerance, replace Shutter block (0-E000) to new one.

The curtain speed and the shutter speed must be checked before install the mirror housing to the body.

*The curtain speed is especially important for 23903 so that 1/2000sec. is adopted.

*The auto-manual speeds are already decided on T100. The auto-manual speeds which decided on T 100 can not get if the adjustment of timing switch in 0-E000 was no good.

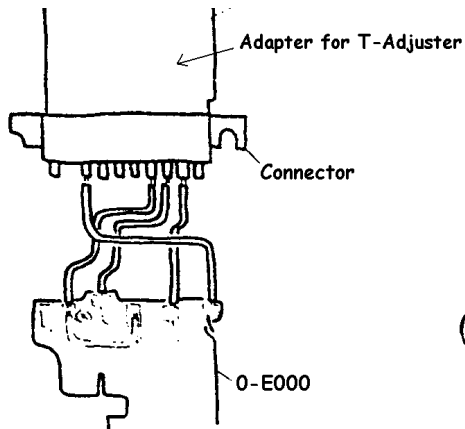

Insert Connector (23900-I 100) to Adapter for T-adjuster. Distribute lead wires as shown left.

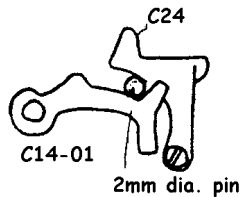

To actuate the auto-manual hutter, install temporary top cover and set the shutter dial AUTO or M, or insert 2 mm diameters pin between C14-01 and C24.

6. Time-sequence of SWg and SWm

It is requested that Adapter for checking the time-sequence of SWg and SWm should be made by your own side.

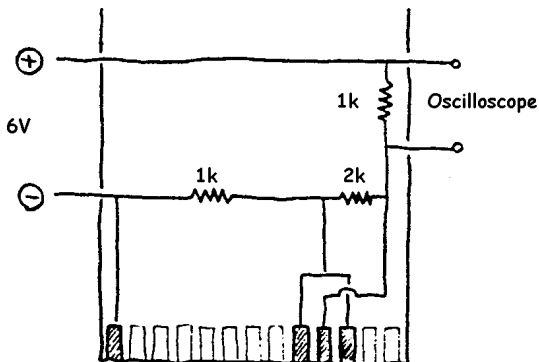

Adjusting procedures and the tolerance are the same as 23900.

7. P.C. board pattern (T100)

1) LED part

LED retainer collar (T212)

CNL-D 1.4 x 2.5

Confirm that LED insulation seal (I18) was sealed on the back side of LED supporting plate.

2) LED positioning

Use P.C. board pattern checker (239 PATTERN CHECKER). Adjust LED position by sliding the LED supporting plate.

Each LED should be aligned with its figure in the view-finder.

3) As installing Photo-cell part to Cell frame (N1), insert P.C. board to the connector.

4) Photo-cell part

- Hot shoe contact piece C (N9)
- T-CNL-E 1.7 x 3
- Insulation plate (N13)
- Insulation collar (N8)
- Hot shoe contact piece A (N4)
- T-CNL-E 1.7 x 4

8. Front board and Mirror housing

Shutter block charged condition
Mirror housing released condition

*1AThen installed, take care about lead wires.

- Front board retainer screw (A132-01) 4pcs.
- W14
- P. C. board retainer (I1)
- CNL-D1.7 x 3 x 2

After installed, check the functions of shutter.

9. Mechanical back focus.

45,46 ± 0.04mm

10. Soldering

The location of solder refer to page 1 and 2.

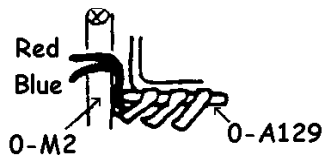

Especially, red and blue lead wire should be positioned between Relay P.C. board assy. (0-A129) and Prism seat assy. (0-M2), as shown left. - to prevent from catching between the top cover and the prism seat.

11. ASA volume (R100)

- ASA volume retainer scerw (A16-01)
- CNL-D 1.7 x 2. 5

12. Bottom cover assy. (A400)

- Connector seat (A23)
- Bottom cover assy. (A400)
- CSS 1.7 x 3 x 2
- CSS 1.7 x 2.2

13. Load the batteries

- G13 x 2

14. Confirm the function of LED of P.C. board pattern and/or LED positioning

*If P.C. board pattern checker is not ready, adjust LED position at this time.

Confirm the function of LED as follows.

- 1) After the main switch was ON, LED stays on about 30 sec..
- 2) LED indicates as Manual-mode at when the top cover does not install.
- 3) LED should be changed the indication when connect the points as mentioned below.

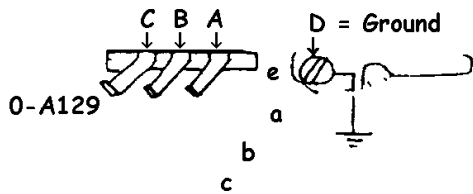

- a. A - D Auto-mode CBA D =ground
- b. B - D Manual-mode
LED keeps down
- c. C - D Manual-mode
LED keeps up

15. Install ASA ring assy. (0-D11-01) temporary.

When set ASA ring out of 1X, red LED of EE should be flickering.

16. Install the temporary top cover.

17. Adjust the auto shutter-speed and the LED indication.

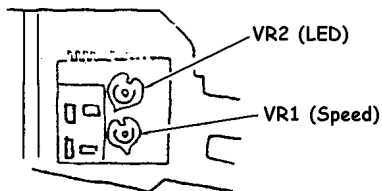

1) Auto shutter-speed

EV12
ASA100 1X
f8 - using f8 set ring
2.8V

Light value correction unit
KA-00- 1A
Regulated D. C. power

supply

Shutter dial AUTO

*Nominal speed 15.6 ms

Adjust by VR1. After adjusted, check other EVs. (EV16 1X, EV16 1/2X, EV8)

Standard of shutter speed is the same as 23900.

*Standard of 1/2000sec.

0.49±0.7EV ms. (0.30 0.81 ms.)

2) LED indication

EV12
ASA 100 1X
f8
2.8V
Shutter dial AUTO

LED of 60 should be turned on at the above combinations.

Adjust by VR2. LED of 60 should not move to next LED when changed ASA from 80 to 125.

After adjusted, check other EVs.

3) Auto manual-speed and the indication
Shutter dial M

Shutter speed tester (7F-9A-

- a. Check the curtain speed at 1/1000sec.. 6.5ms or faster at 21mm distance
- b. Check each shutter speed from 1/2000 sec. ~ 4 sec..
- c. Each LED should be turned on when changed the shutter speed, and OVER or UNDER LED must be flickering when non-proper exposure was made.

*As a general rule, use Light value correction unit and Shutter speed tester (7F-9A-2) for checking and/or adjusting the shutter speed and the indication. However, Shutter speed tester (7PE-25A3) may use by the circumstances.

4) LED indication and Shutter speed under the full-charged condition of AF-200S or AF-160

When load 2.4V between the ground and Hot shoe contact piece A (N4), LED indication and the shutter speed are as below.

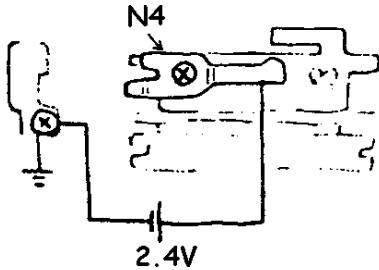

- a. LED indication M - flickering
 125X - on
- b. Shutter speed
 9.6 -- 11.8ms

5) Battery check

- | | |
|-------|-----------------------|
| 2.4V | LED off or flickering |
| 2.65V | LED on |

18. Remove ASA ring and the temporary top cover

19. Clean the view-finder

*Do not use the air-compressed blower to clean the view-finder. It will be caused by taking out Shutter speed indication plate (M10).

20. Top cover assy. (A300)

Check the conductivity of Switch board (A318) before install Top cover assy. (A300).

a. At Shutter dial AUTO

- | | |
|-----------------------|-----|
| A - the ground | ON |
| B - the ground | OFF |
| C - the ground | OFF |

a. At Shutter dial M

- | | |
|-----------------------|-----|
| A - the ground | OFF |
| B - the ground | OFF |
| C - the ground | OFF |

When pushed the bottom side button,

- | | |
|-----------------------|----|
| B - the ground | ON |
|-----------------------|----|

When pushed the up side button,

- | | |
|-----------------------|----|
| C - the ground | ON |
|-----------------------|----|

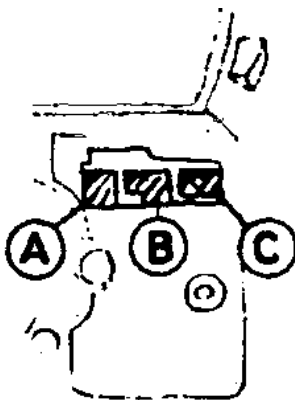

If the conductivity of Switch board (A318) was good, install Top cover assy. (A300).

The point of installation is the same as 23900 ME.

Cover frame (A131)
Top cover retainer screw A (A333) 2pcs.
Top cover retainer screw B (A334)
Top cover retainer screw C (A332) 2pcs.
Top cover retainer screw D (A335)

After installed, check the function of LED by changing the shutter dial.

21. ASA ring assy. (0-D11-01), Rewinding knob assy. (0-D6)
ASA ring assy. (0-D11-01)
Washer (D21)
Nut (D15)

After installed, check the function of click of ASA ring assy. (0-D11-01). and the LED indication.

At 1/4X, 1/2X, 2X and 4X except 1X, EF red LED must be flickering. If not, check the clearance of Elf switch contact piece (A44) and lead wires and/or adjust Elf index plate (D23) assembled in ASA ring assy.

(0-D11-01), as shown below.

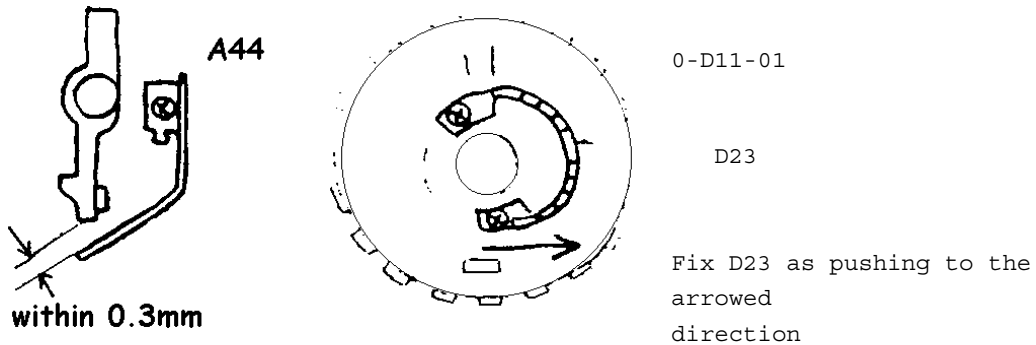

Rewinding knob assy. (0-D6)

22. Winding lever assy. (0-C69)
Winding lever friction spring (C7-01)
Winding lever assy. (0-C69)
Winding lever nut (C8) left handed 23600K0C134-A-2
Cover screw (C139-01) left handed 23600K-C135-A

Check the function of shutter and winding.

23. Check the shutter button stroke Shutter dial Bulb
- When pushed the shutter button deeper than 0. 2mm from the original position, LED should be turned ON before release the shutter.
Main switch ON position
 - After released 1st curtain, the shutter button can goes down 0. 1 - 0.5mm.

Shutter dial AUTO

- a. Charge the self-timer.
- b. Release the shutter by self-timer under main switch off. (No LED turned on.)
- c. LED should be turned on surely before release the shutter.

If LED is turned on at the same time or after the shutter released, the shutter by actuating with self-timer or winder will be AUTO-TIME at 1st exposure under main switch off. In this case, the clearance of main switch is wider than 0.5mm. The clearance should be adjusted less than 0.5mm.

24. Check the conductivity of Hot shoe and the full-charged indication Checking procedures are the same as 23901 MV.
25. Focusing
26. Remove Self-timer charge lever assy. (0-A118)
27. Body covering
 - Body covering, left (A19)
 - Body covering, right (A20)
28. Self-tirner charge lever assy. (0-A118)
 - W30
 - Self-timer collar (A123)
 - Self-timer charge lever assy. (0-A118)
 - Self-timer screw (A 122)

231K-H50

Special Tools

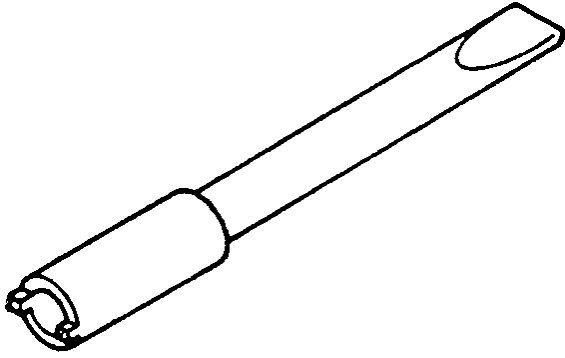

23903k-B95-A

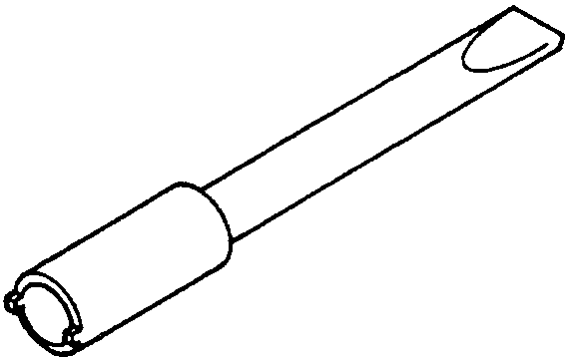

23903K-B96-A

239 PATTERN CHECKER

Body

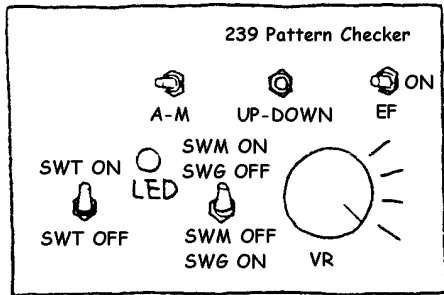
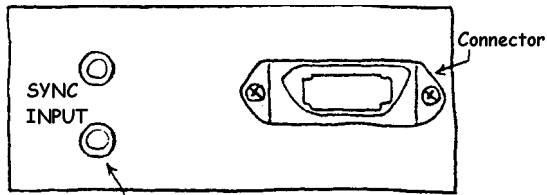

LED - to indicate shutter speed
 Switches
 A-M - Auto-manual switch (for 23903)
 UP-DOWN UP-DOWN switch for manual speed (for 23903)
 *LED goes down when set DOWN position.
 *LED goes up when set UP position.
 EF -EF switch (for 23903)
 *When set ON position, red LED at the top flickering.
 SWT - Timing switch
 SWM/SWG - Memory and Magnet switch

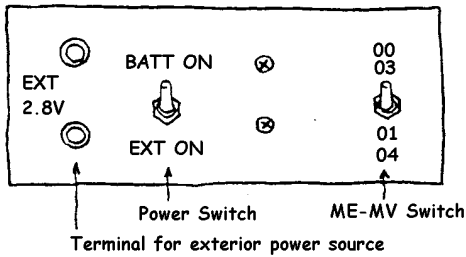

Power switch

*If use G13 x 2, power switch is ON when set BATT ON.
 *If use exterior power- source, power switch is ON when set EXT ON.

Adapter

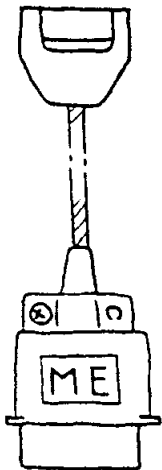

23900 ME

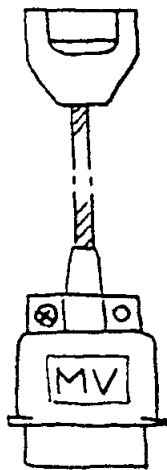

23901 MV
 23904 MV1

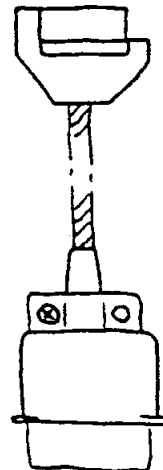

23903 ME Super

How to use

1. Preparation

- a. If use two batteries (G13 x 2), load them to battery case.

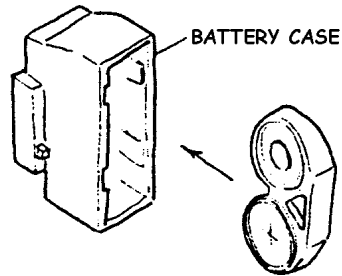

- b. If use exterior power source, connect the body and the exterior power source with connection cord. And set the voltage 2.5V.

2. Check 23900 P.C. board pattern

- a. Install the adapter for ME to the connector.
- b. Set Power switch OFF and insert P.C. board pattern to the connector of adapter.
- c. Set ME-MV switch to ME side
- d. Set Timing switch ON.
- e. Set Memory switch ON.

Check the LED function

- a. Power switch ON. At this time, check LED lights on.
- b. Turn VR-dial and check each LED light on or not. If LEDs in slow speed side does not light on even if VR-dial turned fully, cover up the photo-sensor part step by step.

Check the shutter function

*Shutter speed indicated with LED in P.C. board pattern can be checked by the lighting time of LED of checker body.

- a. Set a shutter speed by turning VR-dial. Slower speed is better to check. To get accurate shutter speed, it need to give constant light on the phot-sensor part.
- b. Set Timing switch OFF.
- c. Set Memory switch OFF.

At this time, LED of checker body lights on for the time indicated on P.C. board pattern.

- d. Repeat the above mentioned process. And check the shutter speed constant or irregular.

*Due to difficulty to confirm the accurate and/or irregular shutter speed, shutter speed checked by LED of checker body is judged a criterion for the time being.

3. Check 23903 P.C. board pattern

- a. Install the adapter for ME-super to the connector.
- b. Set ME-MV switch to ME side.
- c. Insert P. C. board pattern to the connector of adapter.
- d. Check the function and indication of auto-mode.

Check the function and indication of auto-mode

- a. Set A-M switch to A-side.
- b. Checking process is the same as ME mentioned before.

Check the function and indication of manual-mode

- a. Set A-M switch to M-side.
- b. Set UP-DOWN switch OFF position.
- c. Confirm LED movement.
*LED should moves up and/or down to the direction which fixed by UP-DOWN switch.

Check the indication of EF

Red LED at the top should be flickering when set EF switch ON.

4. Check 23901 and 23904 P.C. board pattern
 - a. Install the adapter for MV to the connector.
 - b. Set ME-MV switch to MV side.
 - c. Insert P.C. board pattern to the connector of adapter.
 - d. Checking process is the same as ME. But the application range of VR is opposite.

EXPLODED ILLUSTRATION

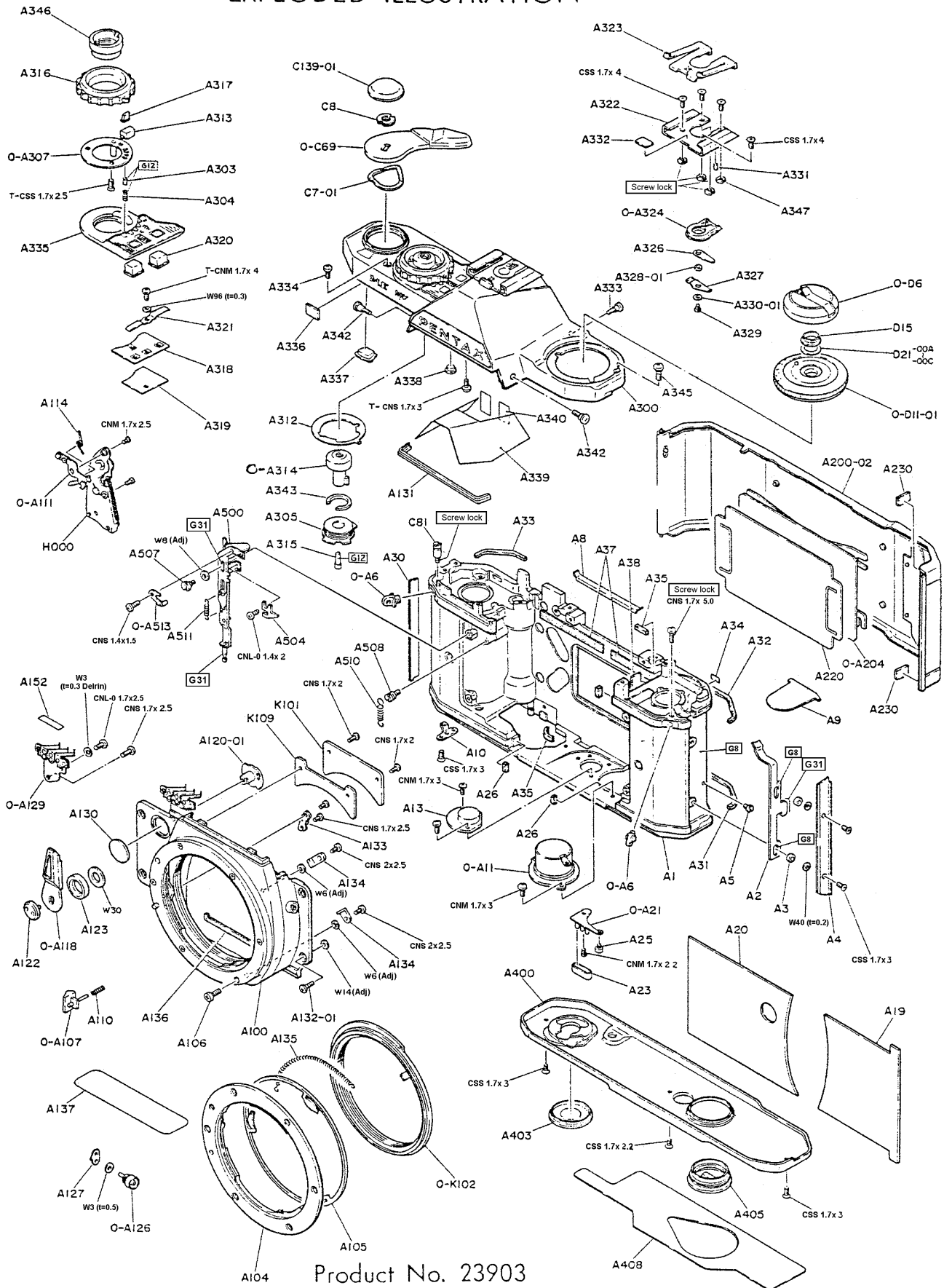

Product No. 23903
PENTAX **MUE** super

Fig. 1

EXPLODED ILLUSTRATION

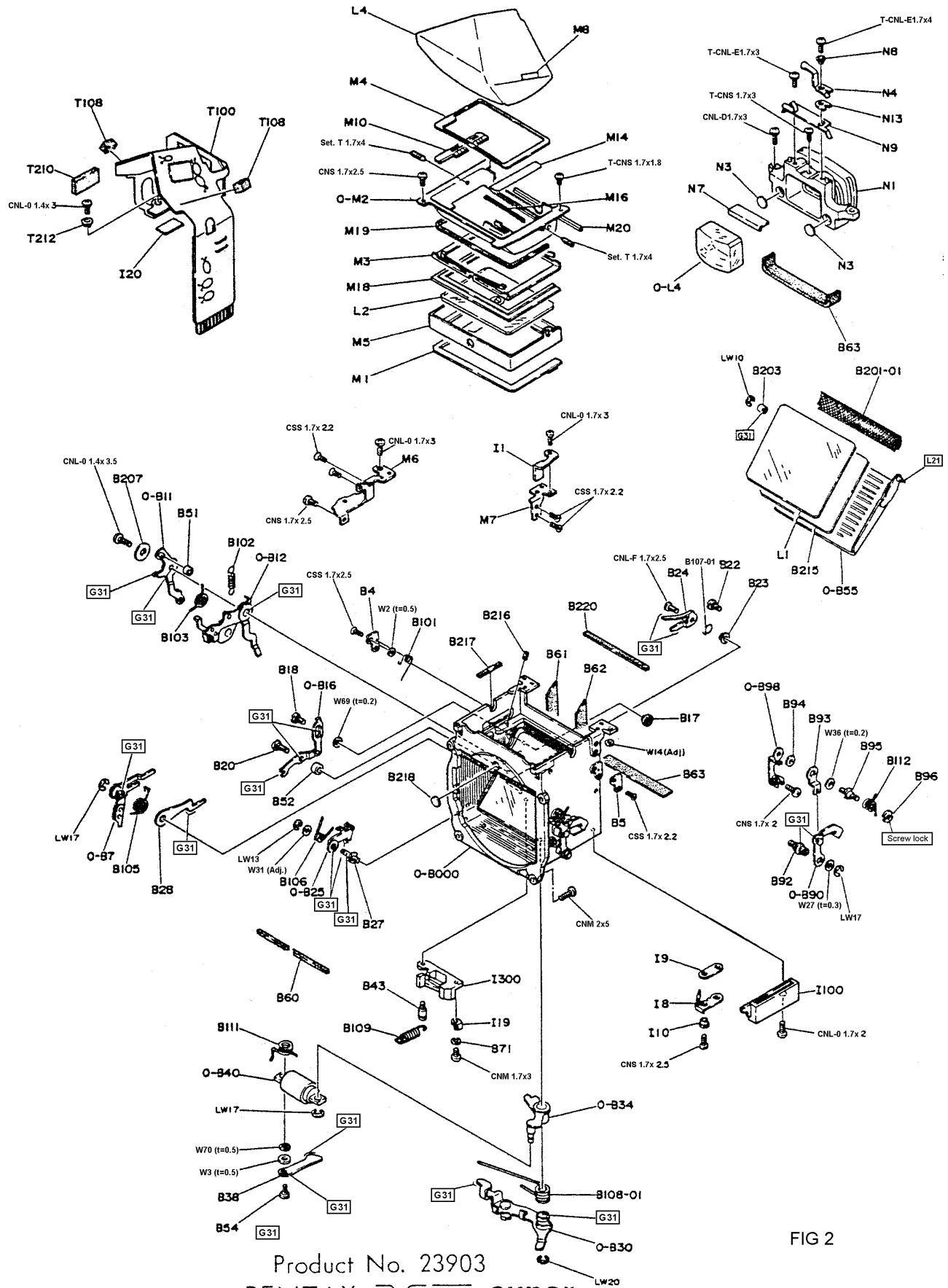
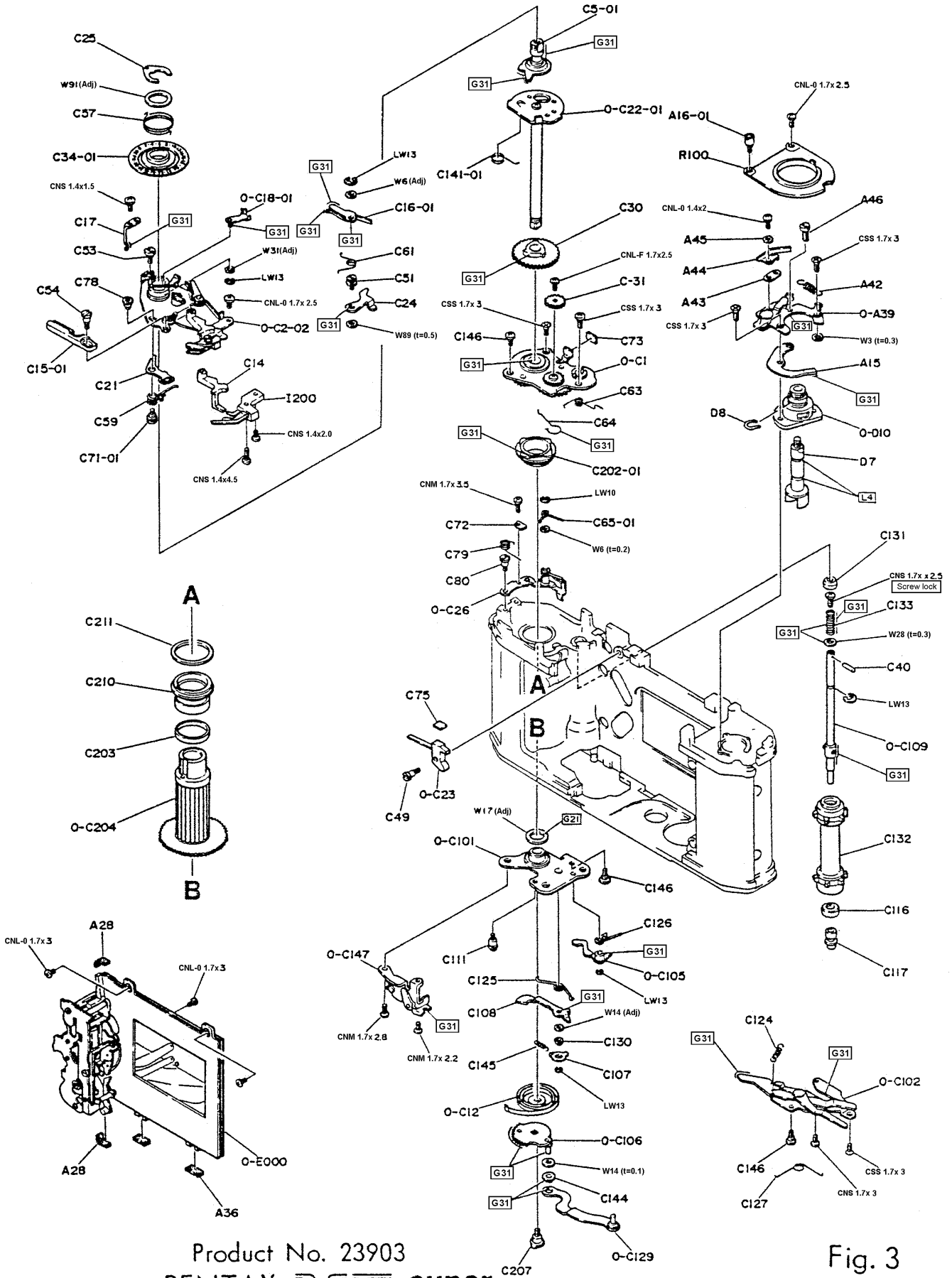

FIG 2

Product No. 23903
PENTAX IMC super

EXPLODED ILLUSTRATION



Product No. 23903
PENTAX IME super

Fig. 3

DISTRIBUTING WIRES

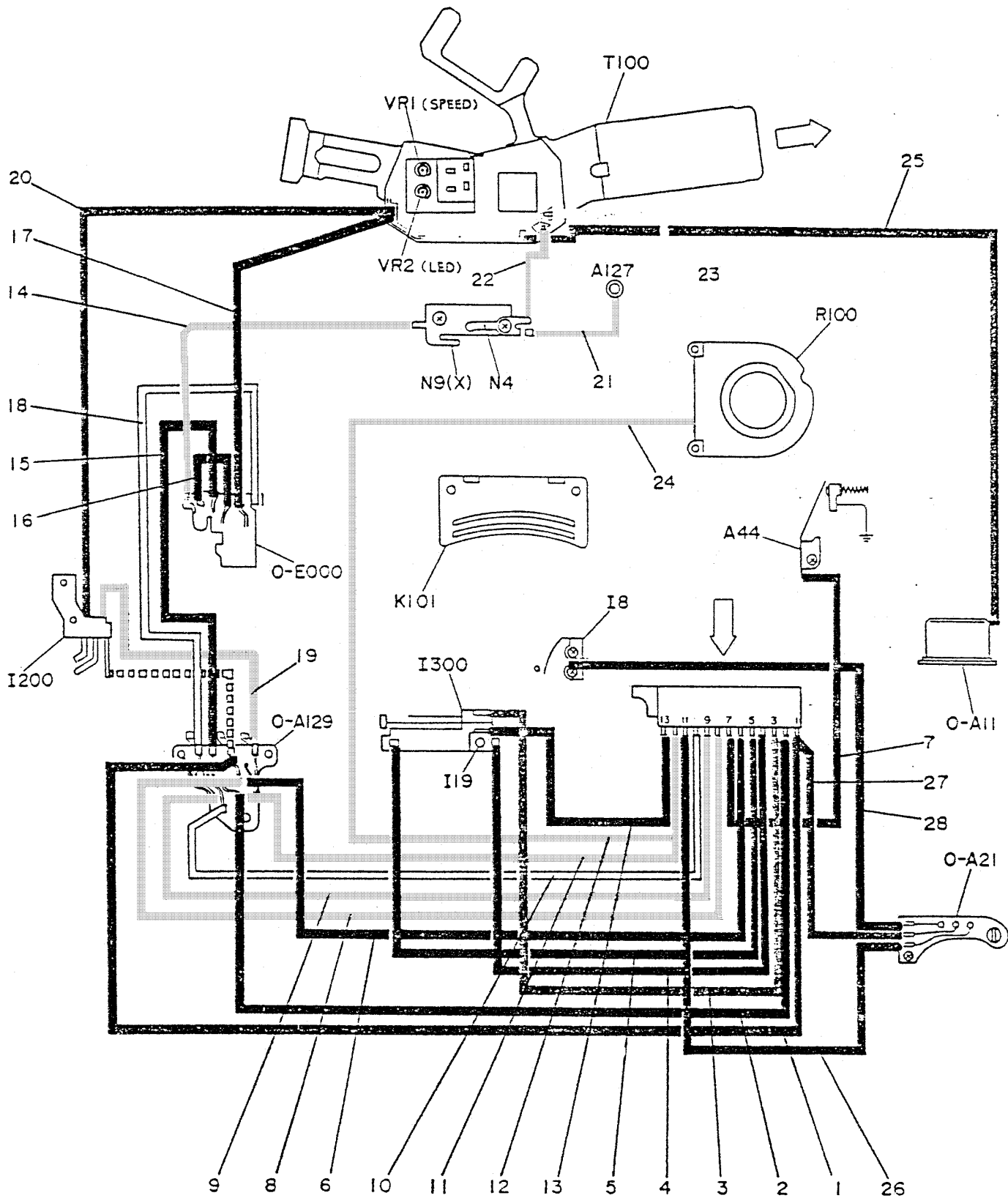

Product No. 23903
PENTAX *IMJ* **super**

Fig. 4

LIST OF SERVICE PARTS

Product No. 23903
PENTAX ME Super

Note: 1: The parts with numbers starting '0-' are assemblies
2: Only available parts are listed below.

Parts No.	Description	Qty	Interchangeability
A2	Back cover key	1	23900-A2
A3	Back cover key collar	2	23900-A3
A4	Back cover key retainer plate	1	23900-A4
A5	Back cover guide screw	1	23900-A5
0-A6	Strap hook assembly (A6, A18)	2	23900-0-A6
A8	Shutter light seal cover	1	23900-A8
A9	Cassette receptacle	1	23900-A9
A10	Back cover shaft receptacle	1	23900-A10
0-A11	Battery case assembly (A11, A12, A14)	1	23900-0-A11
A13	Tripod seat	1	23900-A13
A15	Back cover key retainer spring	1	23901-A15
A16-01	ASA volume retainer screw	1	23901-A16-02
A19	Body covering, left	1	23900-A19
A20	Body covering, right	1	23900-A20
0-A21	Connector base plate assembly (A21, A22, A24 x 3)	1	23900-0-A21
A23	Connector seat	1	23900-A23
A25	Connector retainer screw	1	23900-A25
A26	Light seal D	3	23900-A26
A28	Light seal F	2	23900-A28
A30	Light seal	1	23900-A30
A31	Light seal A	1	23900-A31
A32	Light seal B	1	23900-A32
A33	Light seal C	1	23900-A33
A34	Light seal tape	1	23900-A34
A35	Light seal	1	23900-A35
A36	Light seal	2	23900-A35
A37	Light seal	2	23900-A37
A38	Light seal J	1	23900-A38
0-A39	Exposure-compensation selector seat assy (A39, A40, A41)	1	
A42	Click spring	1	

Parts No.	Description	Qty	Interchangeability
A43	EF switch contact piece installing seat	1	
A44	EF switch contact piece	1	
A45	EF switch contact piece insulation washer	1	
A46	Stopper	1	
A100	Front board assembly (A101, A102, A104, A105, A106 x 6, A107, A108, A109, A110, A117, A121 x 2, A124, A125, A126, A127, A128, A129, A133, A134 x 2, A135, A136, A137, A138, A139 x 3, A151 x 4, K101, K102, K103 x 2, K104, K105 x 2, K106, K107, K108 x 2, K109, CNS 1.7 x 2 x 2, CNS 1.7 x 2.5 x 4, CNS 2 x 2.5 x 2)	1	
A104	Mount ring	1	23900-A104
A105	Mount spring	1	23900-A105
A106	Mount retainer screw	6	23900-A106
0-A107	Mount lock button assembly (A107, A108, A109)	1	23900-0-A107
A110	Mount lock button spring	1	23900-A110
0-A111	Mirror release lever assembly (A111, A112, A113, A114, A115, A116)	1	23900-0-A111
A114	Coupler lever spring	1	23900-A114
0-A118	Self-timer charge lever assembly (A118, A119)	1	23900-0-A118
A120-01	Charge cam	1	23900-A120-01
A122	Self-timer screw	1	23900-A122
A123	Self-timer collar	1	23900-A123
0-A126	Synchro terminal assembly (A126, A124, A125)	1	23900-0-A126
A127	X contact relay plate	1	23900-A127
0-A129	Relay P. C. board (A129, A117, A121 x 2, A138, A139 x 3, A151 x 4)	1	
A130	Light seal plate	1	23900-A130
A131	Cover frame	1	23900-A131
A132-01	Front board retainer screw	4	23900-A132-01
A133	Lock pin supporter plate	1	23900-A133
A134	Diaphragm coupler ring retainer	2	23900-A134
A135	Restitution spring	1	23900-A135
A136	Light seal	1	23900-A136
A137	Scratch protection seal	1	23900-A137
A152	Insulation seal	1	
A200-02	Back cover assembly (A20 1-02, A202, A203, A207, A208 x 2, A209 x 2, A210, A211, A212, A213, A214-02, A219-02, A222-01 x 4, A230 x 2)	1	23900-A200-02

Parts No.	Description	Qty	Interchangeability
0-A204	Pressure plate assembly (A204, A205, A206 x 2)	1	23900-0-A204
A220	Pressure plate cover	1	23900-A220
A230	Light seal	2	23900-A230
A300	Top cover assembly (A301, A303, A304, A305, A307, A 11, A312, A313, A314, A315, A316, A317, A318, A319, A320 x 2, A321, A322, A323, A324, A325, A326, A327, A328, A329, A330, A331, A332, A335, A336, A337, A338, A339, A340 x 2, A341, A343, A344, A347 x 4, D20, CSS 1.7 x 4 x 4, T-CNS 1.7 x 3, T-CSS 1.7 x 2.5 x 3, T-CNM 1.7 x 4)	1	
A303	Click pin	1	
A304	Click pin spring	1	23900-A304
A305	Bearing	1	
0-A307	Click plate assembly (A307, A311)	1	
A312	Auto-manual selector plate	1	
A313	Release button, bottom	1	
0-A314	Shutter buton assembly (A314, A341)	1	23901-0-A314
A315	Shutter button core	1	
A316	Shutter dial	1	
A317	Release button	1	23900-A317
A318	Switchboard	1	
A319	Switch board insulation sheet	1	
A320	Control button	2	
A321	Switch spring	1	
A322	Accessory shoe	1	
A323	Accessory shoe spring	1	
0-A324	Accessory shoe base assembly (A324, A325, A344)	1	
A326	Contact spring A	1	
A327	Contact spring B	1	
A328-01	Collar	1	23900-A328-01
A329	Retainer screw	1	23900-A329
A330-01	Insulation washer	1	23900-A330-01
A331	SW pin	1	23900-A331
A332	Indication plate	1	23900-A332
A333	Top cover retainer screw A	2	23602-A342-01
A334	Top cover retainer screw B	2	
A335	Shutter indicator plate	1	

Parts No.	Description	Qty	Interchangeability
A336	Window A	1	23900-A336
A337	" B	1	23900-A337
A338	" C	1	23900-A338
A339	Insulation tape	1	23900-A339
A340		2	23900-A340
A342	Top cover retainer screw C	2	
A343	Shutter button retainer washer	1	23901-A343
A345	Top cover retainer screw D	1	
A346	Nut	1	
A347	Accessory shoe retainer nut	4	
A400	Bottom cover assembly (A401, A402, A408, C209)	1	23900-A400
A403	Bottom winding cap	1	23900-A403
A405	Battery cap	1	23900-A405
A408	Scratch protection seal	1	23900-A408
A500	Release plate assembly (A501, A502, A503, A505, A506, A509, A512, A513, A514, CNS 1.4 x 5)	1	
A504	Bulb actuator plate	1	23900-A504
A507	Guide screw	1	23900-A507
A508	Spring hook B	1	23900-A508
A510	Release plate restitution spring	1	23900-A510
A511	Connection spring	1	23900-A511
0-A513	SW adjusting plate assembly (A513, A512)	1	
0-B000	Mirror housing complete assembly (B1, B2, B3, B4, B5, B6, B7, B8, B9, B11, B12, B13, B14, B15, B1G, B17, B18, B19, B20, B21, B22 x 2, B23, B24, B25, B26, B27, B28, B30, B31, B32, B33, B34, B35, B36, B37, B38, B39, B40, B41, B42, B43, B44, B45, B51 x 2, B52 x 3, B53, B54, B55, B57, B60 x 2, B61, B62, B63, B70, B71, B81, B82, B83, B84, B85, B86 x 2, B90, B91, B92, B93, B94, B95, B96, B97, B98, B101, B102, B103, B105, B106, B107, B108, B109, B111, B112, B201, B202, B203, B204, B205 x 4, B206, B207, B208, B210, B211, B215, B216 x 3, B217, B218, I8, I9, I10, I19, I300, L1, M6, M7, CSS 1.7 x 2.2 x 6, CSS 1.7 x 2.5 x 2, CNS 1.7 x 2, CNS 1.7 x 2.5 x 3, CNM 1.7 x 3, CNL-D 1.4 x 3.5, CNL-F 1.7 x 2.5, W2, W3, W27, W31, W36, W70, W78, W88, W89, LW10, LW13, LW17 x 3, LW20)	1	
B4	Supporter plate, right	1	23900-B4
B5	Supporter plate, left	1	23900-B5

Parts No.	Description	Qty	Interchangeability
0-B7	Hook lever B assembly (B7, B6, B9, B86 x 2)	1	
0-B11	Mirror actuator lever assembly (B11, B51, B210)	1	
0-B12	Diaphragm coupler lever assembly (B12, B13, B15, B51, B81, B82, B83, B84, B208, W88)	1	
0-B16	Restitution link A assembly (B16, B19, B36)	1	23900-0-B16
B17	Slide shaft nut	1	23900-B17
B18	Restitution link slide shaft	1	23900-B18
B20	Restitution link B shaft	1	2390Q-B20
B22	Spring hook	2	
B23	Release lever shaft	1	23900-B23
B24	Release lever	1	23900-B24
0-B25	Restitution actuator lever hook plate assy. (B25, B26)	1	23900-0-B25
B27	Restitution actuator lever hook plate shaft	1	23900-B27
B28	Mirror up lever	1	23900-B28
0-B30	Restitution actuator lever assembly (B30, B31, B33, B44, B211)	1	
0-B34	Shock absorber connection lever assembly. (B34, B35, B39, B57)	1	
B38	Shock absorber lever	1	23900-B38
0-B40	Shock absorber assembly (B40, B41, B42, B45)	1	
B43	Restitution spring hook screw	1	23900-B43
B51-00A	Mirror actuator collar a	2	23900-B51-00A
-00B	" " " b		23900-851-00B
-00C	" " " c		23900-851-00C
-00D	" " " d		23900-851-00D
B32-00A	Shock absorber collar a	3	
-00B	" " " b		
-00C	" " " c		
-00D	" " " d		
-00E	" " " e		
B54	Shock absorber lever shaft	1	23900-B54
0-B55	Mirror seat assembly (B55, B2, B3, B201, B202, B203, B204, B205 x 4, B206, LW10)	1	23900-0-B55
B60	Light seal	2	23900-B50
B61	Light seal A	1	23900-B61
B62	Light seal B	1	23900-B62
B63	Light seal C	2	23900-B63
B71	Spring washer	1	23900-B71

Parts No.	Description	Qty	Interchangeability
0-B90	Dumper plate assembly (B90, B91)	1	
B92	Dumper plate shaft	1	
B93	Connection lever	1	
B94	Friction washer	1	
B95	Connection lever shaft	1	
B96	Nut	1	
0-B98	Mirror seat adjusting plate assembly (B98, B97)	1	
B101	Mirror seat restitution spring	1	23900-B101
B102	Diaphragm actuator lever spring	1	23900-B102
B103	Diaphragm actuator spring	1	
B105	Hook lever restitution spring	1	
B106	Restitution actuator lever hook plate spring	1	23900-B106
B107-01	Release lever restitution spring	1	23900-B107-01
B108-01	Mirror flip-up spring	1	
B109	Mirror restitution spring	1	
B111	Shock absorber lever spring	1	
B112	Connection lever spring	1	
B201-01	Light seal curtain	1	23900-B201-01
B203	Collar	1	23900-B203
B207	Washer	1	23900-B207
B215	Mirror adhesive tape	1	23900-B215
B216	Focus adjusting screw	3	23900-B216
B217	Light seal	1	23900-B217
B218	Dust prevention seal	1	23900-B218
B220	Light seal	1	23900-B220
0-C1	Top mech. plate assembly (C1, C13, C20, C27, C28, C29, C31, C32, C33, C37, C43, C44, C46, C60, C63, C64, C66, C142-01, CNL-F 1.7 x 2.5, W13, W75)	1	23900-0-C1
0-C2-02	Winding seat assembly (C2-02, C4-01, C6, C14, C16-01, C17, C18-01, C21, C24, C39, C47, C50-02, C51, C52, C59, C61, C71-01, C76, C78, I200, CNS 1.4 x 2, CNS 1.4 x 4.5, CNM 1.4 x 1.4, W6, W89, LW13 x 2)	1	
C5-01	Winding lever click cam	1	23901-C5-01
C7-01	Winding lever friction spring	1	23900-C7-01
C8	Winding lever nut	1	23900-C8
0-C12	Winding spring assembly (C12, C137, C138)	1	23900-0-C12
C14	Switch actuating lever	1	

Parts No.	Description	Qty	Interchangeability
C15-01	Counter dial indicator	1	23901-C15-01
C16-01	Receiving claw	1	23901-C16-01
C17	Winding lever click spring	1	23900-C17
0-C18-01	Transporting claw assembly (C18-01, C47)	1	23900-0-C18-01
C21	Release lock lever	1	
0-C22-01	Winding shaft assembly (C22-01, C48 x 2, C67 x 2, C68, C140, C141-01, C154, C201)	1	23900-0-C22-0101
0-C23	Cocked indicator assembly (C23, C74)	1	
C24	Shutter control lever	1	
C25	Counter retainer plate	1	23900-C25
0-C26	Winding stopper assembly (C26, C41-01, C42, C65, C77, LW10)	1	23901-0-C26
C30	Main gear	1	23900-C30
C31	2nd gear	1	23900-C31
C34-01	Counter dial	1	23901-C34-01
C40	Sprocket shaft pin	1	23900-C40
C49	Cocked indicator lever shaft	1	
C51	Restriction lever shaft	1	23900-C51
C53	Winding seat retainer screw	1	23900-C53
C54	Counter dial indicator retainer screw	1	23901-C54
C57	Counter dial spring	1	23900-C57
C59	Release lock lever spring	1	23900-C59
	Shutter restriction lever spring	1	23900-C61
C63	Cam lever spring	1	23900-C63
C54	Silent ratchet spring	1	23900-C64
C65-01	Transporting claw spring	1	23901-C65-C1
0-C69	Winding lever assembly (C69, C70)	1	23900-0-C69
C71-01	Release lock lever shaft	1	
C72	Winding shaft retainer	1	23900-C72
C73	Transporting marker	1	23900-C73
C75	Cocked indication marker	1	23900-C75
C78	Counter dial indicator stopper	1	23901-C78
C79	Winding lever click spring	1	23900-C79
C80	Winding stopper retainer screw	1	23900-C80
C81	Strap hook retainer	1	23900-C81
0-C101	Bottom mech. plate assembly (C101, C110, C118, C120)	1	23900-0-C101
0-C102	Winding guide plate assembly (C102, C103, C104, C112, C113, C114)	1	23900-0-C102

Parts No.	Description	Qty	Interchangeability
0-C105	R lever assembly (C105, C119)	1	23900-0-C105
0-C106	Winding lever ratchet wheel assembly (C106, C121, C122, C128)	1	23900-0-C106
C107	Winding lever ratchet	1	23900-C107
C108	Winding hook lever	1	23900-C108
0-C109	Sprocket shaft assembly (C109, C134, C135, C136)	1	23900-0-C109
C111	Spring hook screw	1	23900-C111
C116	Sprocket seat	1	23900-C116
C117	R button	1	23900-C117
C124	Winding hook coupler spring	1	23900-C124
C125	Hook lever spring	1	23900-C125
C126	R lever spring	1	23900-C126
C127	Mirror charge lever spring	1	23900-C127
0-C129	Shutter charge lever assembly (C129, C115, C123)	1	23900-0-C129
C130	Winding ratchet collar	1	23900-C130
C131	Sprocket collar	1	23900-C131
C132	Sprocket	1	23900-C132
C133	Sprocket spring	1	23900-C133
C139-01	Cover screw	1	23900-C139-01
C141-01	Winding ratchet spring	1	23900-C141-01
C144	Shutter charge collar	1	23900-C144
C145	Winding ratchet spring	1	23900-C145
C146	Seat plate retainer screw	5	23900-C146
0-C147	Bottom release assembly (C147, C148, C149, C150, C151, C152, C153)	1	23900-0-C147
C202-01	Spool cam	1	23900-C202-01
C203	Friction ring	1	23900-C203
0-C204	Spool assembly (C204, C205 x 14, C206, C208)	1	23900-0-C204
C207	Joint	1	23900-C207
C210	Spool cam receptacle	1	23900-C210
C211	Light seal washer	1	23900-C211
0-D6	Rewind knob assembly (D6, D1, D2, D3, D4, D5, CNM 1.4 x 2 x 2)	1	23900-0-D6
D7	Rewinding shaft	1	23900-D7
D8	Rewinding shaft spring	1	23900-D8
0-D10	Rewinding shaft bearing assembly (D10, D8, D9)	1	23900-0-D10

Parts No.	Description	Qty	Interchangeability
O-D11-01	ASA dial assembly (D11-01, D12, D13, D14 x 3, D16, D17, D18 x 3, D19, D23, T-CNS 1.4 x 2.5 x 2)	1	
D15	Nut	1	23900-D15
D21-00A	Washer a (t=0.1mm)	1	23900-D21-00A
-00B	" b (t=0.15mm)		23900-D21-00B
-00C	" c (t=0.2mm)		23900-D21-00C
0-E000	Shutter block	1	
0-1-1000	Self-timer	1	23900-0-K000
I 1	P.C. board retainer	1	23901-I 1
I 8	Winder switch contact	1	
I 9	Insulation plate	1	
I 10	Collar	2	
I 19	Lug plate	1	23901-I 19
I 20	Insulation seal	1	
I 100	Connector		
I 200	Main switch	1	
I 300	Memory and magnet switch block	1	23900-I 300
K101	f-volume	1	23900-K101
0-K102	Diaphragm coupler ring assembly (K102, K103 x 2, K104, K105 x 2, K106, K107, K108 x 2)	1	23900-0-K102
K109	Insulation seat	1	23900-K109
L1	Mirror	1	23900-L1
L2	Fresnel lens	1	
L3	Penta prism	1	23900-L3
0-L4	Eyepiece assembly (L4, L5)	1	23900-0-L4
M1	Focusing screw receptacle plate	1	23900-M1
0-M2	Prism seat assembly (M2, M4, M9 x 2, M10, M14, M16)	1	
M3	Focusing plate retainer	1	23900-M3
M4	Finder mask		
M5	Fresnel lens frame	1	
M6	Supporter plate, right	1	
M7	Supporter plate, left		
M8	Prism protection sheet	2	23900-M8
M10	Shutter speed scale indication plate	1	
M14	Spacer	1	23900-M14
M16	Light seal	1	23900-M16
M18	Fresnel lens retainer plate	1	23900-M18
M19	Dust prevention seal A	1	23900-M19

Parts No.	Description	Qty	Interchangeability
M20	Dust prevention seal B	1	23900-M20
N1	Cell frame	1	
N3	Light metering lens	2	23900-N3
N4	Shoe contact piece A	1	
N7	Eyepiece protector	1	23900-N7
N8	Insulation collar	1	23901-N8
N9	Shoe contact piece C	1	
N13	Insulation plate	1	23901-N13
R100	ASA volume assembly	1	
T100	P.C. board assembly	1	
T108	P.C. board retainer	2	23900-T108
T210	Dust prevention seal	1	23900-T210
T212	LED retainer collar	1	

LIST OF STANDARD PARTS

Product No. 23903
PENTAX ME Super

Small Screws:

Description	Surface Treatment	Position of Use	Qty
CSS 1.7 x 2.2	Black nickel	0-B000, B5	2
		0-B000, M6	2
		0-B000, M7	2
CSS 1.7 x 2.2	Nickel	A1, A400	1
CSS 1.7 x 2.5	Black nickel	0-B000, B4	2
CSS 1.7 x 3	" "	A1, A4	2
		A1, A10	2
		A1, 0-A39	2
		A1, 0-C1	1
		A1, 0-C102	1
CSS 1.7 x 3	Nickel	A1, A400	2
CSS 1.7 x 4	Black nickel	A300, A322	4
CNS 1.4 x 1.5	" "	A500, Q-A513	1
		0-C2-02, C17	1
CNS 1.4 x 2	" "	0-C2-02, I200	1
CNS 1.4 x 4.5	" "	0-C2-02, I200	1
CNS 1.7 x 1.8	" "	0-M2, M6	1
		0-M2, M7	1
CNS 1.7 x 2	" "	A100, K101	2
CNS 1.7 x 2.5	" "	A100, 0-A129	2
		A100, A133	2
		0-B000, I10	2
		0-B000, 0-M2	2
		0-B000, M6	1
		C40, 0-C109	1
CNS 1.7 x 3	" "	A1, 0-C102	1
		0-B000, 0-B98	1
CNS 1.7 x5	" "	A1, 0-A6	1
CNS 2 x 2.5	" "	A100, A134	2
CNM 1.7 x 2.2	" "	A1, 0-A21	1
		A1, 0-C147	1
CNM 1.7 x 2.8	" "	A1, 0-C147	1
CNM 1.7 x 3	" "	A1, 0-A11	2
		A1, A13	2
		0-B000, B71	1
CNM 1.7 x 3.5	" "	A100, 0-H000	2
		0-C26, C72	1
CNL-D 1.4x 2	" "	A1, A45	1
		A1, A504	1
CNL-D 1.4 x 3	" "	T100, T212	1
CNL-D 1.4 x 3.5	" "	0-B000, B207	1
CNL-D 1.7 x 2	" "	0-B000, 1100	1

Description	Surface Treatment	Position of Use	Qty
CNL-D 1.7 x 2.5	Black nickel	A1, 0-C2-02	1
		A1, R100	1
CNL-D 1.7 x 3	" "	A1, I 1	1
		A1, M6	1
		A1, 0-E000	2
		N1, M6	1
		N1, M7	1
CNL-D 1.7 x 3	Black zinc	A1, 0-E000	1
CNL-F 1.7 x 2.5	Black nickel	0-B000, B24	1
		0-C1, C31	1
T-CSS 1.7 x 2.5	" "	0-A307, A316	3
T-CNS 1.7 x 3	" "	A1, A335	1
		N1	1
T-CNM 1.7 x 4	" "	A300, A321	1
T-CNL-E 1.7 x 3	" "	N1, N9	1
T-CNL-E 1.7 x 4	" "	N1, N8	1
Set T 1.7 x 4	" "	0-M2	2

Washers:

Description	Material	Thickness	Position of Use	Qty
W2	Brass	0.5mm	0-B000, B4	1
W3	Delrin	0.3	0-A129	1
W3	Brass	0.3	A1, 0-A139	1
		0.5	0-A126, A127	1
		0.5	B38, 0-B40	1
W6	"	0.03, 0.05, 0.1	A100, A134	2
		0.1, 0.15	C16-01	1
		0.2	0-C26	1
W8	"	0.08, 0.1, 0.15	A500, A507	1
W13	"	0.1	0-C1	1
W14	"	0.1, 0.15	A1, A100	4
		0.1, 0.2, 0.3, 0.4	A1, M6	1
		0.1, 0.2, 0.3, 0.4	A1, M7	1
		0.1	0-C106, C144	1
		0.05, 0.1, 0.15	C108, C130	1
W17	Steel	0.15, 0.2, 0.3	0-C101	1
W27	Brass	0.3	0-B90	1
W28	"	0.3	0-C109, C132	1
W30	"	0.1	A100, A123	1
W31	"	0.1, 0.2	0-B25	1
		0.05, 0.07, 0.1	0-C18-01	1
W36	"	0.2	B93, B95	1
W40	"	0.2	A3, A4	2
W70	"	0.5	B38, 0-B40	1
W89	"	0.2	0-B16	1
		0.5	C24	1

Description	Material	Thickness	Position of Use	Qty
W91	"	0.05, 0.07, 0.1, 0.15	C25	1
W96	"	0.3	A321	1

Lock Washers:

Description	Material	Position of use	Qty
LW10	Steel	B203	1
		0-C26	1
LW13	"	B27	1
		C16-01	1
		0-C18-01	1
		0-C101	2
		0-C109	1
LW17	"	0-B7	1
		0-B40	1
		0-B90	1
LW20	"	0-B30	1

Lead wires:

Lead wire No.	Length	Color	Position of use	Qty
1	136mm	Blue	I100, 0-A129	1
2	125	Brown	I100, 0-A129	1
3	40	Orange	I100, I300	1
4	40	Black	I100, I19	1
5	50	Purple	I100, I300	1
6	125	Green	I100, 0-A129	1
7	105	Purple	I100, A44	1
8	125	Skyblue	I100, 0-A129	1
9	120	Gray	I100, 0-A129	1
10	120	White	I100; 0-A129	1
11	125	Pink	I100, 0-A129	1
12	105	Yellow	I100, K101	1
13	40	Purple	I100, I300	1
14	55	Gray,	N9, 0-E000	1
15	2.0	Brown	0-A129, 0-E000	1
16	13	Black	0-E000	1
17	40	Blue	T100, 0-E000	1
18	20	White	0-A129, 0-E000	1
19	20	Pink	I200, 0-A129	1
20	40	Red	I200, T100	1
21	50	Gray	N4, 0-A126	1
22	35	Pink	N4, T100	1
23	40	Yellow	R100, T100	1

Lead wire No.	Length	Color	Position of use	Qty
24	55	Yellow	R100, K101	1
25	110	Red	T100, 0-A11	1
26	50	Blue	I100, 0-A21	1
27	50	Red	I100, 0-A21	1
28	55	Green	I8, 0-A21	1